

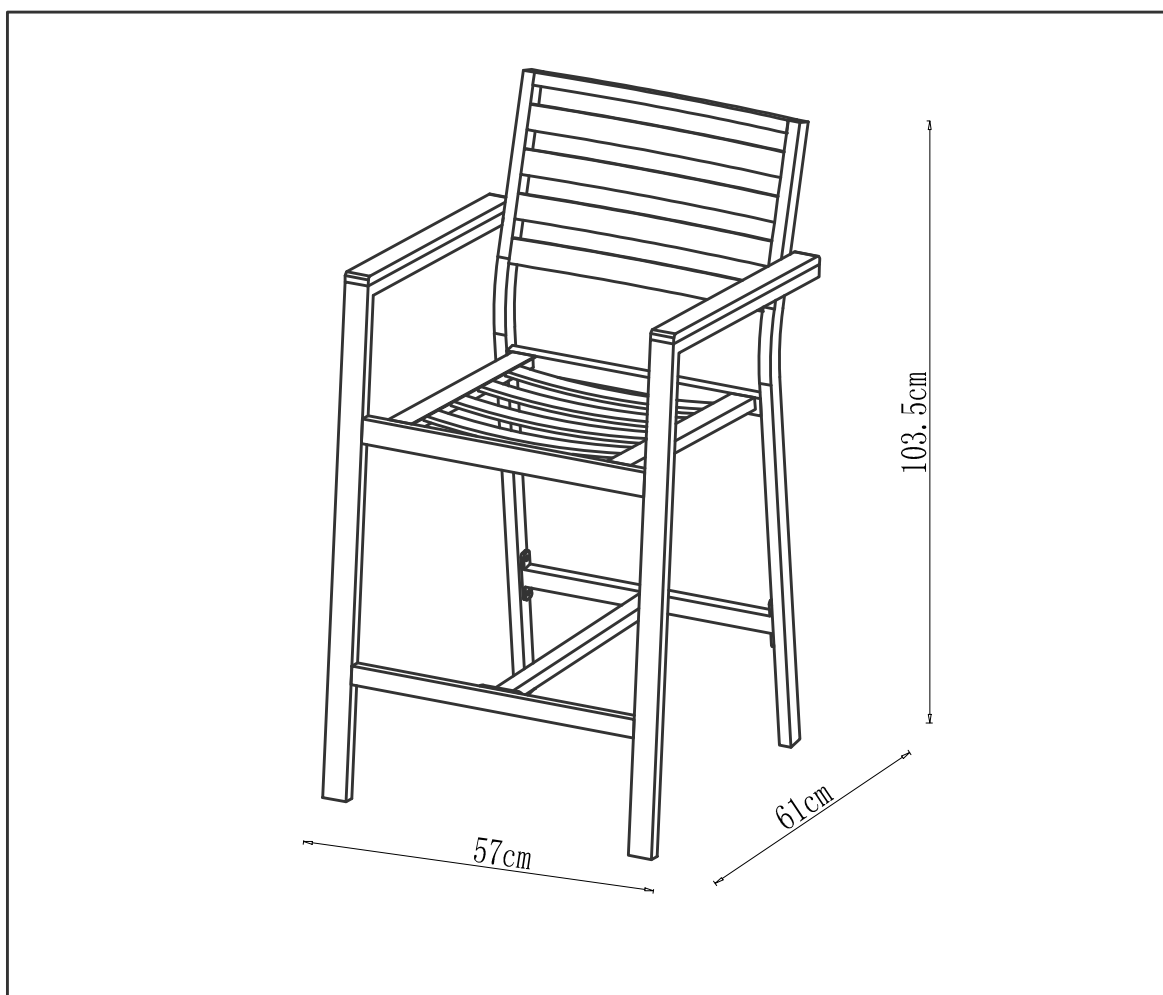

ASSEMBLY INSTRUCTION  
MORNINGTON OUTDOOR BAR CHAIR

ITEM CODE - 65462

Imported by Amart Furniture Pty Ltd, Qld, Brisbane Australia .  
For any assistance with assembly or for missing parts please phone  
Amart Furniture , Customer Service Freecall 1800 351 084



Imported by Amart Furniture Pty Ltd, Qld, Brisbane Australia .  
For any assistance with assembly or for missing parts please phone  
Amart Furniture, Customer Service Freecall 1800 351 084

## PRE-ASSEMBLY PREPARATION

### Before you start:



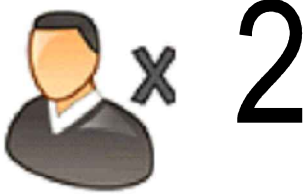

1. Choose a clean, level, spacious assembly area. Avoid hard surfaces that may damage the product.
2. Take care when lifting. Product should be assembled as near as possible to the point of use.
3. Ensure that you have all required contents for complete assembly.
4. Always read the assembly instructions carefully before beginning assembly.
5. Keep all hardware parts and packaging out of reach of small children.
6. Do not over tighten the screws and bolts as this may damage the threads.

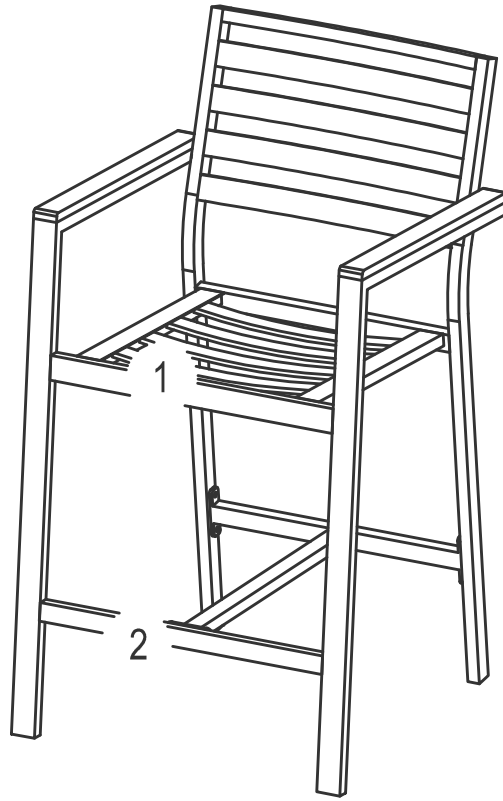
	
ALLOW 20 MINUTES	PEOPLE REQUIRED
ADDITIONAL TOOLS REQUIRED	

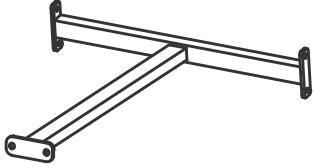
# PARTS LIST







<p>1 Seat panel</p>  <p>6PCS</p>	<p>2 Fixed link</p>  <p>6PCS</p>
---	---

<p>A. Bolt</p>  <p>M6*20*36PCS</p>	<p>B. Hexagon Key</p>  <p>M6*1PC</p>	<p>C. Shim</p>  <p>M6*36PCS</p>	<p>D. Screw cap</p>  <p>M6*36PCS</p>
---	---	--	---

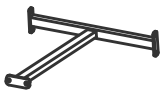
# Step 1:

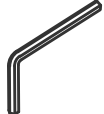
## ITEMS REQUIRED

1. Seat panel 1PC 	2. Fixed link 1PCS 		
A. Bolt  M6*20*6PCS	B. Hexagon Key  M6*1PC	C. Shim  M6*6PCS	D. Screw cap  M6*6PCS

- Attach fixed link (2) to seat panel (1) using bolt (A) with shim (C) & screw cap (D).
- Then attach fixed link(2) to front brace.
- Tighten with hexagon key (B) .

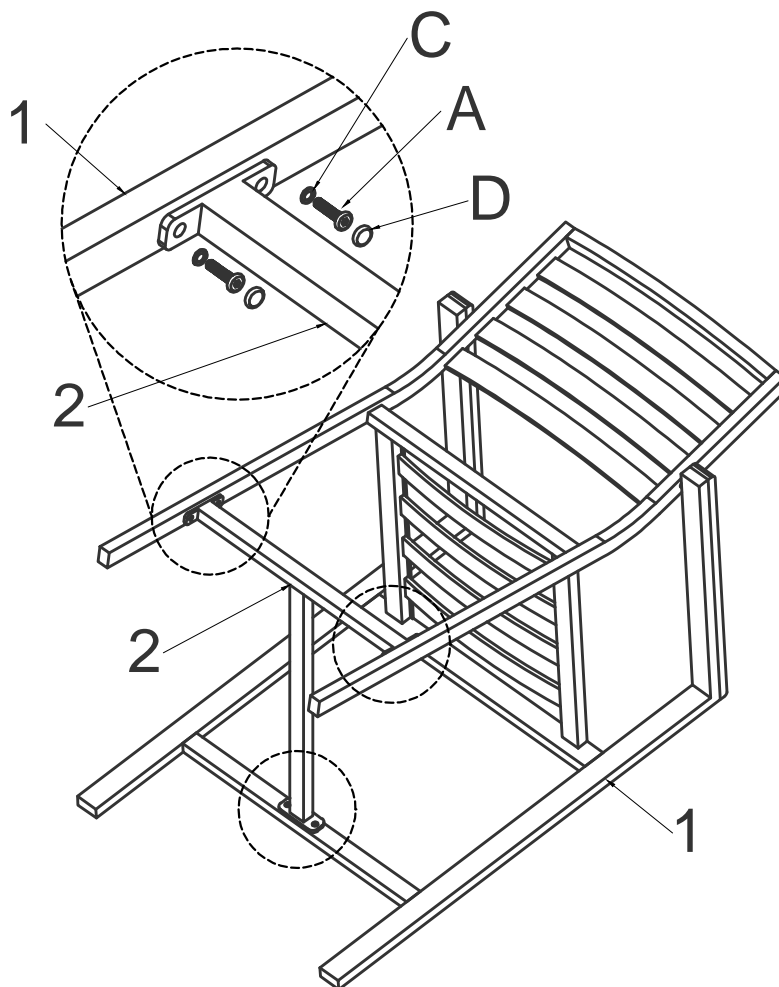

**ASSEMBLY IS COMPLETE**

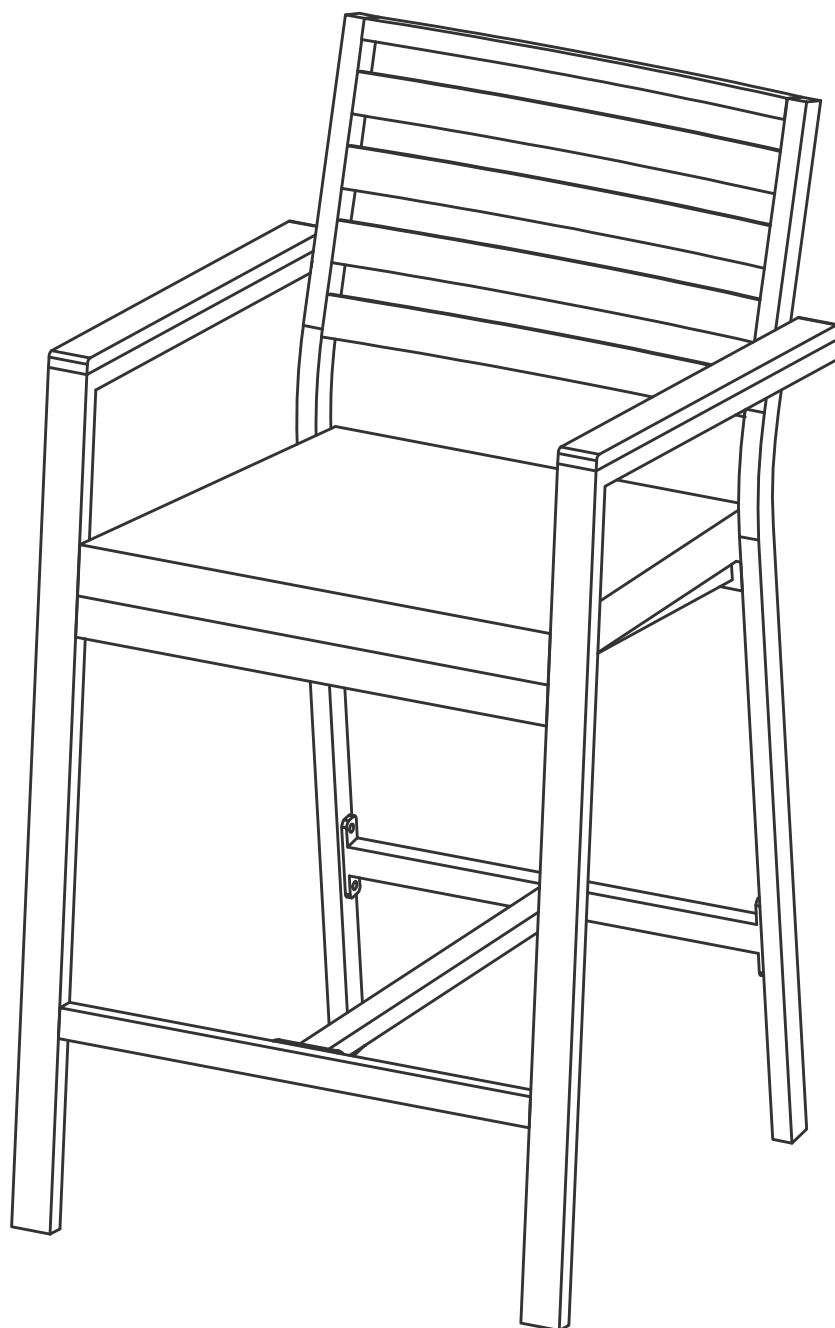

# Care and maintenance



## Cushions

- ☒ Direct exposure to the Sun's harmful UV rays is likely to cause rapid colour fading to fabrics. For best results we recommend avoiding exposure to direct sunlight.
- ☒ To ensure product longevity it is recommended outdoor products are not left permanently exposed to the elements.
- ☒ Spot clean using mild detergent and a soft clean cloth. Rinse in lukewarm water.
- ☒ Do not tumble dry.
- ☒ Do not bleach.
- ☒ Do not dry clean.
- ☒ Cool iron onl.

## Weathergrain

- ☒ Item is designed for use outdoors. However we do not recommend leaving this product outside when not in use.  
To preserve the life of this item, avoid prolonged exposure to the elements & store inside/under cover or use an outdoor cover.
- ☒ DO NOT place heavy or pointed objects on the surface of the weathergrain while using your outdoor furniture.
- ☒ DO NOT place magnifying objects on top of weathergrain in direct sunlight. Items such as wine glasses, reading glasses, etc. This may cause your product to burn.
- ☒ Leaving your outdoor furniture outside in direct sunlight may cause your product to become weak and brittle. Your product may also experience colour fading.
- ☒ DO NOT place hot objects on the surface of the weathergrain as it may damage the product.
- ☒ Wipe the surface of the weathergrain with mild soap and water.
- ☒ Do not clean your weathergrain item with solvents or any other aggressive chemicals.

## Aluminium

- ☒ Item is designed for use outdoors. However we do not recommend leaving this product outside when not in use. To preserve the life of this item, avoid prolonged exposure to the elements & store inside/under cover or use an outdoor cover.
- ☒ DO NOT allow the furniture to be left in the rain or left wet for extended periods of time.
- ☒ Wipe furniture Dry immediately after it becoming wet.
- ☒ DO NOT clean your furniture down with any harsh solvents, abrasives or chemicals.
- ☒ To remove dirt and grime, simply rinse with fresh water or periodically clean using a sponge and mild detergent solution as required